

CLB 2.64 80A

- Used to sense the current load of a medical insulated power supply system, which is monitored by the insulation monitoring device from HAKEL.
- Available in the range of primary current 25 A to 100 A, secondary current 5 A.
- Construction is pluggable, is supplied in two dimensional versions, depending on the primary current.
- Designed for installation in an IPS panel, they can be mounted to the distribution board using reduction brackets (included), or using a DIN rail bracket (must be purchased separately).
- Alternatively, the transformer can be mounted directly on the copper profile, up to a maximum size of 20 x 10 mm.
- Work reliably with HAKEL HIG95-DELTA and HIG95+ insulation monitoring devices.

Type		CLB 2.64 80A
Primary current		80 A
Secondary side current		5 A
Power	P	2.5 W
Accuracy class		1
Overcurrent number (FS)		5
Transformer construction		Pluggable (without interrupting the primary conductor)
Frequency	f	50 ÷ 60 Hz
Housing material		Self-extinguishing
Recommended cross-section of connected conductors	S	1.5 ÷ 2.5 mm ²
Operating position		Any
Operating temperature	θ	-25 ÷ 40 °C
Article number of DIN rail bracket		71 540
Designed according to standards		
Instrument transformers – General requirements		IEC 61869-1:2007
Instrument transformers – Additional requirements for current transformers		IEC 61869-2:2012
Application standards		
Low-voltage electrical installations – Medical locations		HD 60364-7-710:2012
Insulation monitoring devices for medical locations (MED-IMD)		IEC 61557-8:2014 annex A
Ordering, packaging and additional data		
Mass	m	520 g
Mass (including the packaging)	m	544 g
Packaging dimensions (H x W x D)		60 x 113 x 73 mm
Packaging value	V	0.5 dm ³
Customs tariff no.		85043129
EAN code		8590681270936
Art. number		71 535



The link in the QR code leads to the online presentation of the **CLB 2.64 80A**. There, in addition to the always up-to-date data sheet, you will also find all diagrams and drawings, declarations of conformity, or 2D or 3D models and other necessary materials. For more information, visit www.hakel.com



Application wiring diagram (installation)

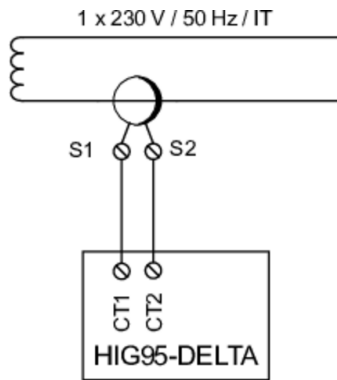

Internal diagram

